

2 - 6 Horse Gooseneck Slant with Dress

**Safe,
Comfortable,
Versatile
and Stylish.**

HAWK's design experience and attention to detail equals unmatched quality and value. Travel in confidence with the industry leader.



*60/40 rear doors
provide easy and
safe loading.*

Standard Features Include:

- Fully Lined and Insulated Walls and Doors
- White or Silver Aluminum Outer Shell
- Custom Painted Accent Color
- Fiberglass Roof and Fenders
- Powder Coated Removable Interior Parts
- T-Coated Latches and Hardware
- Transferrable Warranty
- Sealed Fuse Box



Hawk
T R A I L E R S



T R A I L E R S

2 & 3 Horse Gooseneck Slant

	2 H. Custom	2 H. Elite	3 H. Custom	3 H. Elite
Overall Length	21'10"	21'10"	25'6"	25'6"
Width 80"	S	S	S	S
Stall Width, 44"	S	S	S	S
Inside Height 7'-4"	S	S	S	S
2-5/16" Stallion Gooseneck coupler	S	O	S	O
2-5/16" Fulton Gooseneck coupler w/cable release	O	S	O	S
Single speed single leg jack	S	S	S	S
Axle Capacity 7000# w/4 wheel electric brakes	S	S	10400	10400
ST22575R15(C) Radial Silver rims, Elite Aluminum rims	S	S	(D)	(D)
Spare Tire & rim w/vinyl cover	S	S	S	S
20x24 wdw in dress door	O	S	O	S
D.S. Sidewall, 20x24 wdw (1) per horse	S	S	S	S
1/3-2/3 Rear door w/20x24 wdw in 2/3 rear door	S	S	S	S
Fold down feed wdw 24x31 w/separate cage	2	1	3	2
R.S. 35" Escape door w/24x31 drop feed wdw separate cage	O	S	O	S
Gooseneck Sidewall wdw 20x51 (1) each side	S	S	S	S
Carpet on floor in dress & Gooseneck floor	S	S	S	S
Carpet on bulkhead wall & jacksheet wall	O	S	O	S
Saddle racks	2	2	3	3
Bridle hooks weld in (6) Tack wall	S	S	S	S
Bridle hook set bolt on (6) aluminum Dress area	O	S	O	S
Door tie backs on all doors	S	S	S	S
Aluminum running boards	O	S	O	S
Diamond plate on fenders & steps Elite only full fenders	S	S	S	S
Diamond plate on Gooseneck gussets & 18" under nose	O	S	O	S
48" high kickwall rubber no pads	S	S	S	S
48" high kneewall rubber	O	S	O	S
Std height rubber on bulkhead wall	O	S	O	S
48" rubber on 2/3 rear door	O	S	O	S
Padding on bulkhead wall	1"	2"	1"	2"
Kickwall pads	O	O	O	O
Divider pads	1"	2"	1"	2"
Rear header pad	S	S	S	S
Floor mats 5/8"	S	S	S	S
Roof vents	2	2	3	3
Brush tray on dress door	S	S	S	S
Triangle feed bag (1) per stall	S	S	S	S
Interior head ties (3) per stall	S	S	S	S
Exterior head ties (1) per horse	S	S	S	S
Fuse block	S	S	S	S
Dome lights	2	4	3	5
D.O.T Lighting	S	S	S	S
Empty trailer weight	4600 lbs		5900 lbs	
Limited warranty on all products. See dealer for details.	5yr	7yr	5yr	7yr

HAWK TRAILERS RESERVES THE RIGHT TO CHANGE SPECIFICATIONS AND PRICES WITHOUT NOTICE.

Some trailers pictured with optional equipment.

EFFECTIVE 3/21/04

3 Horse Gooseneck Slant With Dress

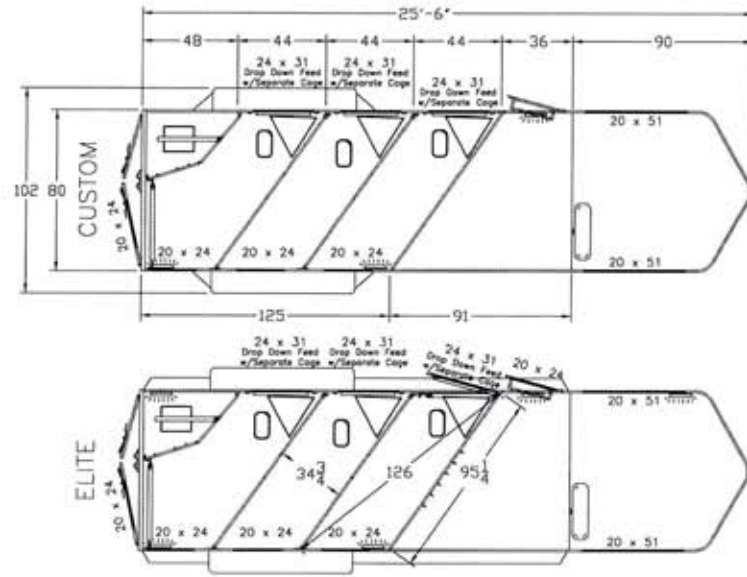

2 Horse Gooseneck Slant With Dress

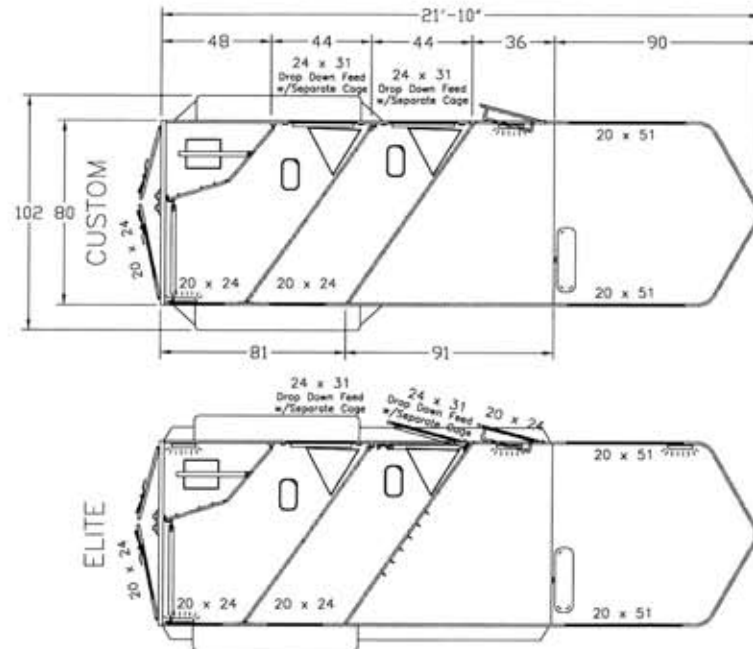

HAWK TRAILERS

2 & 3 Horse Gooseneck Slant

	2 H. Custom 21'10"	2 H. Elite 21'10"	3 H. Custom 25'6"	3 H. Elite 25'6"
Overall Length				
Width 80"	S	S	S	S
Stall Width, 44"	S	S	S	S
Inside Height 7'-4"	S	S	S	S
2-5/16" Stallion Gooseneck coupler	O	O	O	O
2-5/16" Fulton Gooseneck coupler w/cable release	S	S	S	S
Single speed single leg jack	S	S	S	S
Axle Capacity 7000# w/4 wheel electric brakes	S	S	10400	10400
ST22575R15(D) Radial Silver rims, Elite Aluminum rims	S	S	(D)	(D)
Spare Tire & rim w/vinyl cover	S	S	S	S
20x24 wdw in dress door	O	S	O	S
D.S. Sidewall, 20x24 wdw (1) per horse	S	S	S	S
1/3-2/3 Rear door w/20x24 wdw in 2/3 rear door	S	S	S	S
Fold down feed wdw 24x31 w/separate cage	2	1	3	2
R.S. 35" Escape door w/24x31 drop feed wdw separate cage	O	S	O	S
Gooseneck Sidewall wdw 20x51 (1) each side	S	S	S	S
Carpet on floor in dress & Gooseneck floor	S	S	S	S
Carpet on bulkhead wall & jacksheet wall	O	S	O	S
Saddle racks	2	2	3	3
Bridle hooks weld in (6) Tack wall	S	S	S	S
Bridle hook set bolt on (6) aluminum Dress area	O	S	O	S
Door tie backs on all doors	S	S	S	S
Aluminum running boards	O	S	O	S
Diamond plate on fenders & steps Elite only full fenders	S	S	S	S
Diamond plate on Gooseneck gussets & 18" under nose	O	S	O	S
48" high kickwall rubber no pads	S	S	S	S
48" high kneewall rubber	O	S	O	S
Std height rubber on bulkhead wall	O	S	O	S
48" rubber on 2/3 rear door	O	S	O	S
Padding on bulkhead wall	1"	2"	1"	2"
Kickwall pads	O	O	O	O
Divider pads	1"	2"	1"	2"
Rear header pad	S	S	S	S
Floor mats 5/8"	S	S	S	S
Roof vents	2	2	3	3
Brush tray on dress door	S	S	S	S
Triangle feed bag (1) per stall	S	S	S	S
Interior head ties (3) per stall	S	S	S	S
Exterior head ties (1) per horse	S	S	S	S
Fuse block	S	S	S	S
Dome lights	2	4	3	5
Remote switch interior lights	O	S	O	S
D.O.T Lighting	S	S	S	S
Empty trailer weight	4600 lbs		5300 lbs	
Limited warranty on all products. See dealer for details.	5yr	7yr	5yr	7yr

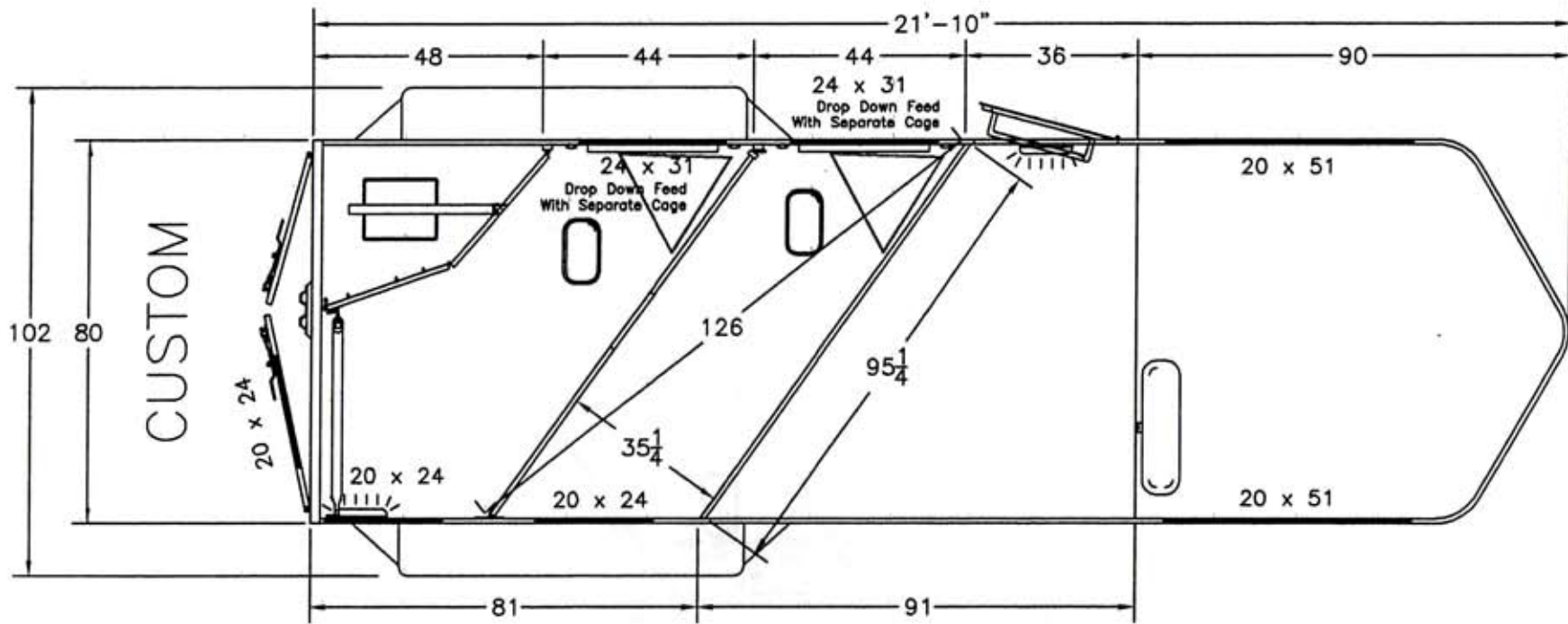

CUSTOM

ELITE

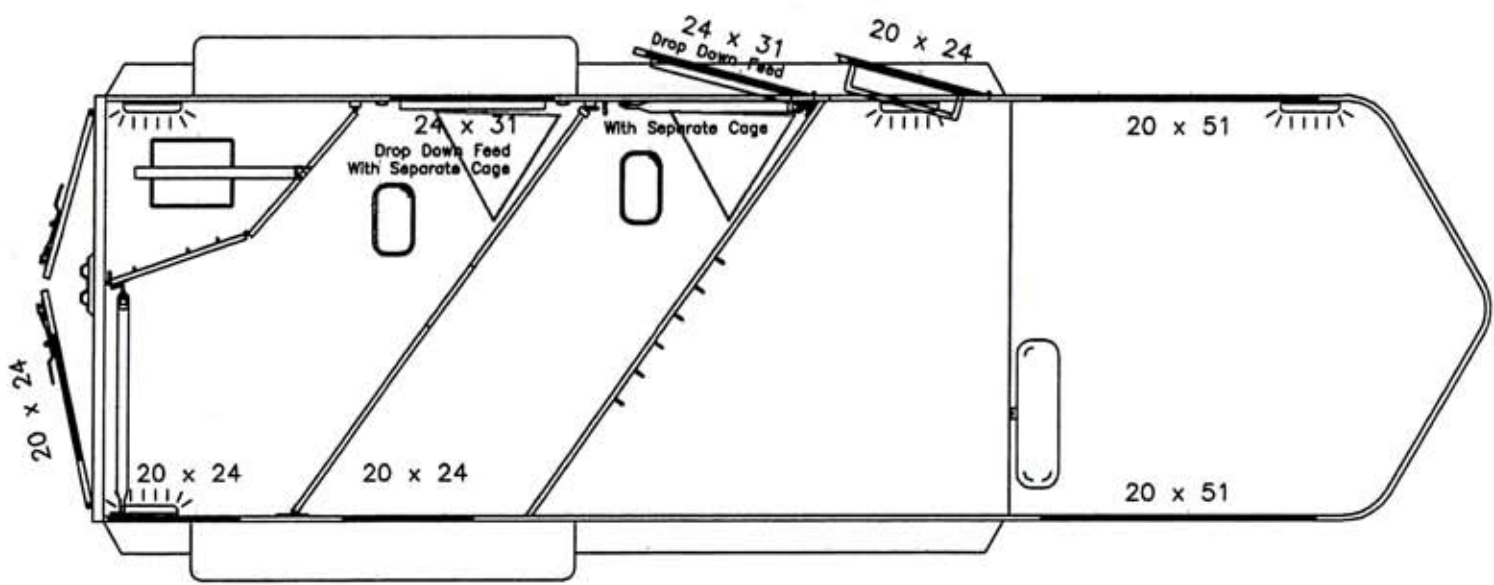

2 Horse Gooseneck Slant With Dress

Drawn: TLS	Date: 12/26/1997	Scale: 1:36	Tolerance: $\pm \frac{1}{16}$	Rev. 3/26/04
---------------	---------------------	----------------	-------------------------------	--------------

2 Horse Gooseneck
Slant w/Dress



Hawk Trailers
MANAWA, WI

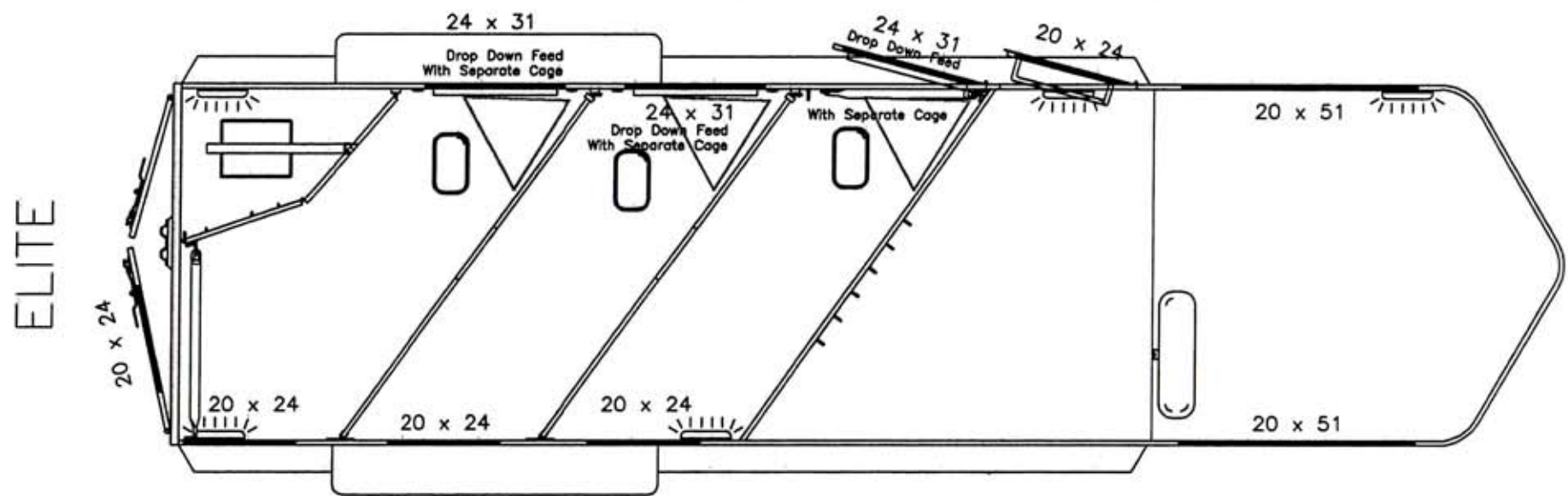
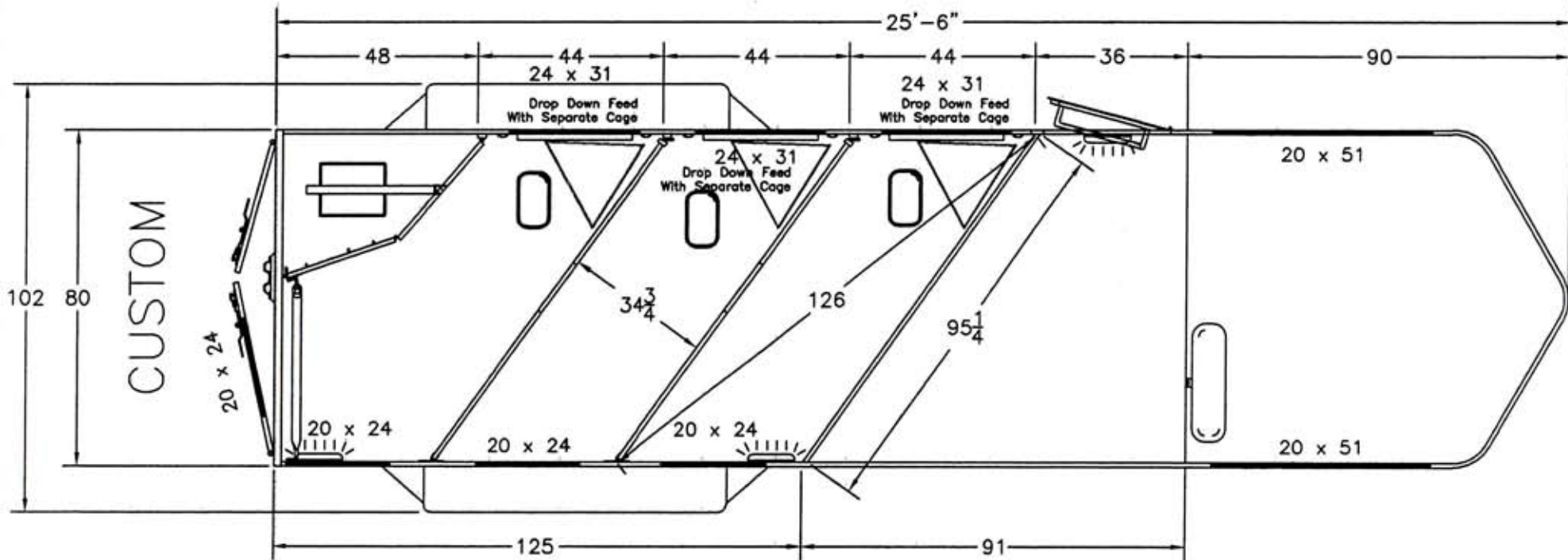

3 Horse Gooseneck Slant With Dress

Drawn:	Date:	Scale:	Tolerance:	Rev.
TLS	12/26/97	1:36	$\pm \frac{1}{16}$	3/26/04

3 Horse Gooseneck Slant
With Dress



Hawk Trailers
MANAWA, WI

HAWK TRAILERS

4 - 6 Horse Gooseneck Slant

	4 H. Custom	4 H. Elite	5 H. Custom	5 H. Elite	6 H. Custom	6 H. Elite
Overall Length	29'2"	29'2"	32'10"	32'10"	36'6"	36'6"
Width 80"	S	S	S	S	S	S
Stall Width, 44"	S	S	S	S	S	S
Inside Height 7'-4"	S	S	S	S	S	S
2-5/16" Stallion Gooseneck coupler	O	O	O	O	O	O
2-5/16" Fulton Gooseneck coupler w/cable release	S	S	S	S	S	S
Dual speed single leg jack	S	S	S	S	S	S
Axle Capacity w/4 wheel electric brakes	12000	12000	14400	14400	14400	14400
ST23580R16(E) Radial Silver rims, Elite Aluminum rims	S	S	(G)	(G)	(G)	(G)
Spare Tire & rim w/vinyl cover	S	S	S	S	S	S
20x24 wdw in dress door	O	S	O	S	O	S
D.S. Sidewall, 20x24 wdw (1) per horse	S	S	S	S	S	S
1/3-2/3 Rear door w/20x24 wdw in D.S. door	S	S	S	S	S	S
Fold down feed wdw 24x31 w/separate cage	4	3	5	4	6	5
R.S. 35" Escape door w/24 x 31 drop feed wdw separate cage	O	S	O	S	O	S
G.N. Sidewall wdw 20x51 (1) each side	S	S	S	S	S	S
Carpet on floor in dress & Gooseneck floor	S	S	S	S	S	S
Carpet on bulkhead wall & jacksheet wall	O	S	O	S	O	S
Saddle racks	4	4	4	4	4	4
Bridle hooks weld in (6) Tack wall	S	S	S	S	S	S
Bridle hook set bolt on (6) aluminum Dress area	O	S	O	S	O	S
Door tie backs on all doors	S	S	S	S	S	S
Aluminum running boards	O	S	O	S	O	S
Diamond plate on fenders & steps Elite only full fenders	S	S	S	S	S	S
Diamond plate on Gooseneck gussets & 18" under nose	O	S	O	S	O	S
48" high kickwall rubber no pads	S	S	S	S	S	S
48" high kneewall rubber	O	S	O	S	O	S
Std height rubber on bulkhead wall	O	S	O	S	O	S
48" rubber on 2/3 rear door	O	S	O	S	O	S
Padding on bulkhead wall	1"	2"	1"	2"	1"	2"
Kickwall pads	O	O	O	O	O	O
Divider pads	1"	2"	1"	2"	1"	2"
Rear header pad	S	S	S	S	S	S
Floor mats 5/8"	S	S	S	S	S	S
Roof vents	4	4	5	5	6	6
Brush tray on dress door	S	S	S	S	S	S
Triangle feed bag (1) per stall	S	S	S	S	S	S
Interior head ties (3) per stall	S	S	S	S	S	S
Exterior head ties (1) per horse	S	S	S	S	S	S
Fuse block	S	S	S	S	S	S
Dome lights	3	5	3	5	4	6
Remote switch interior lights	O	S	O	S	O	S
D.O.T Lighting	S	S	S	S	S	S
Empty trailer weight	6300 lbs		7100 lbs		8000 lbs	
Limited warranty on all products. See dealer for details.	5yr	7yr	5yr	7yr	5yr	7yr

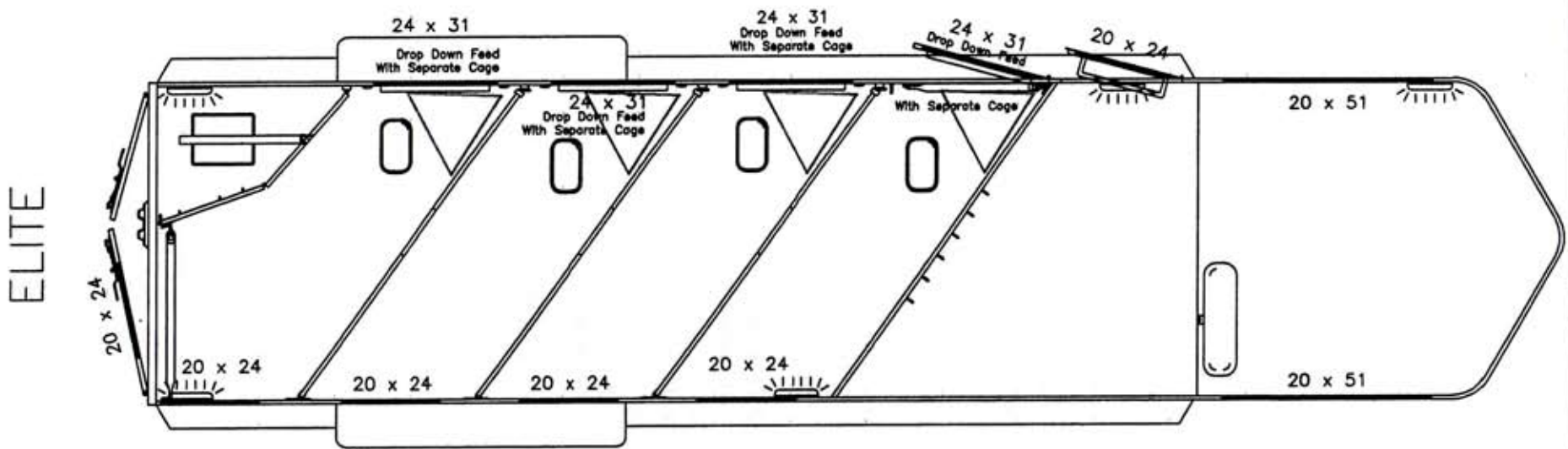
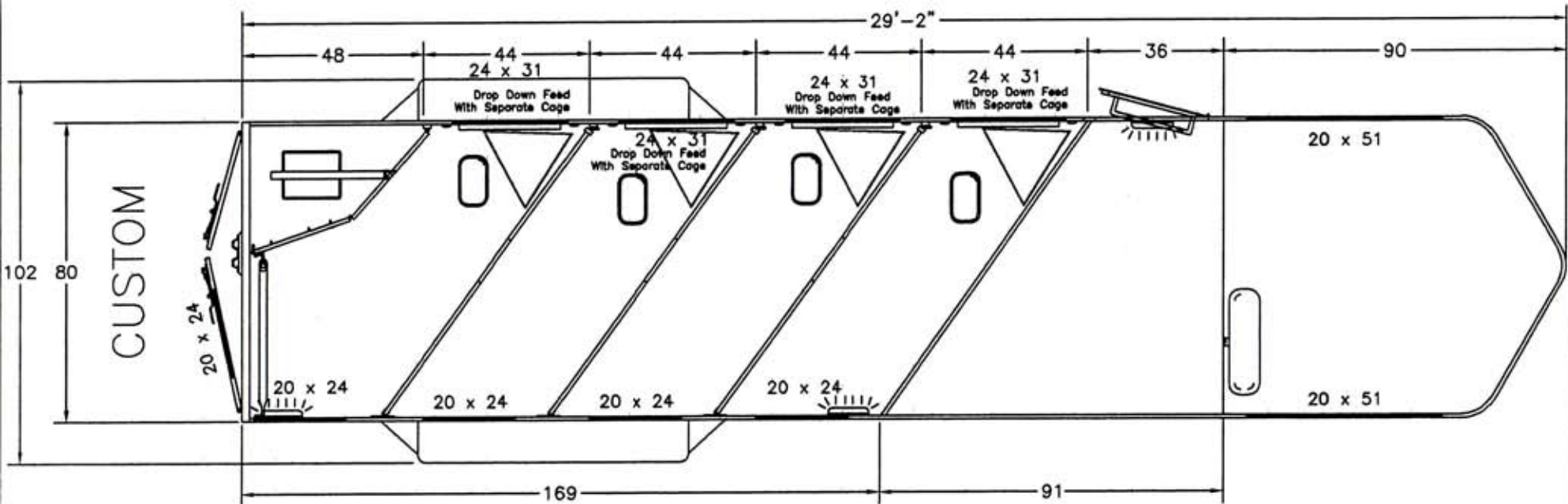

4 Horse Gooseneck Slant With Dress

Drawn:	Date:	Scale:	Tolerance:	Rev.
TLS	12/26/1997	1:40	$\pm \frac{1}{16}$	3/26/04

4 Horse Gooseneck Slant w/Dress

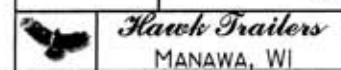

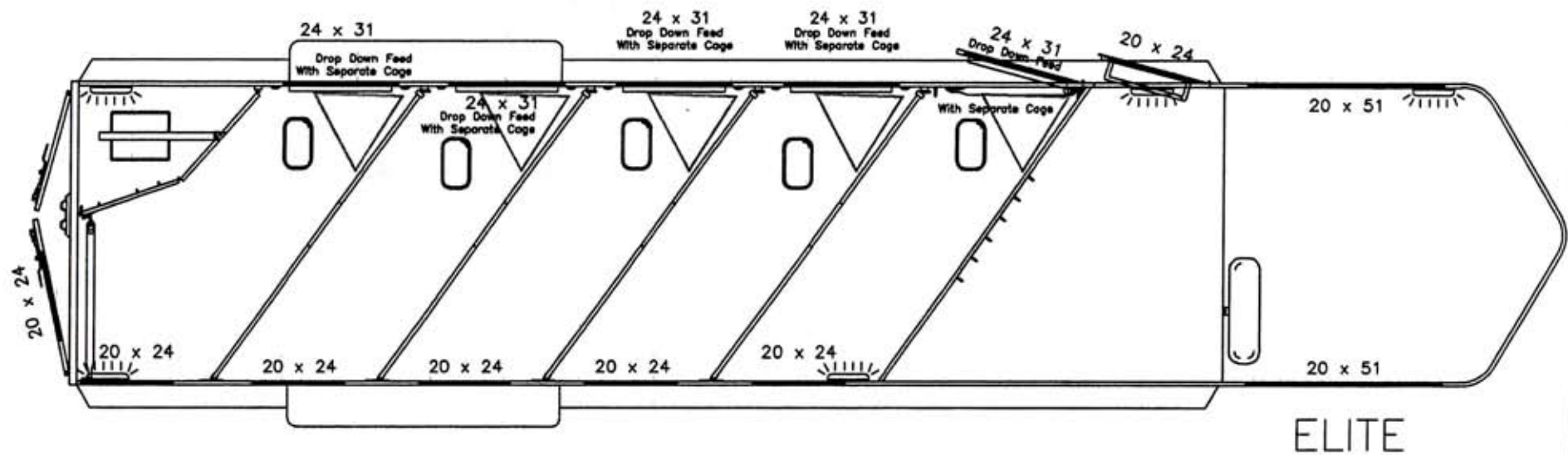
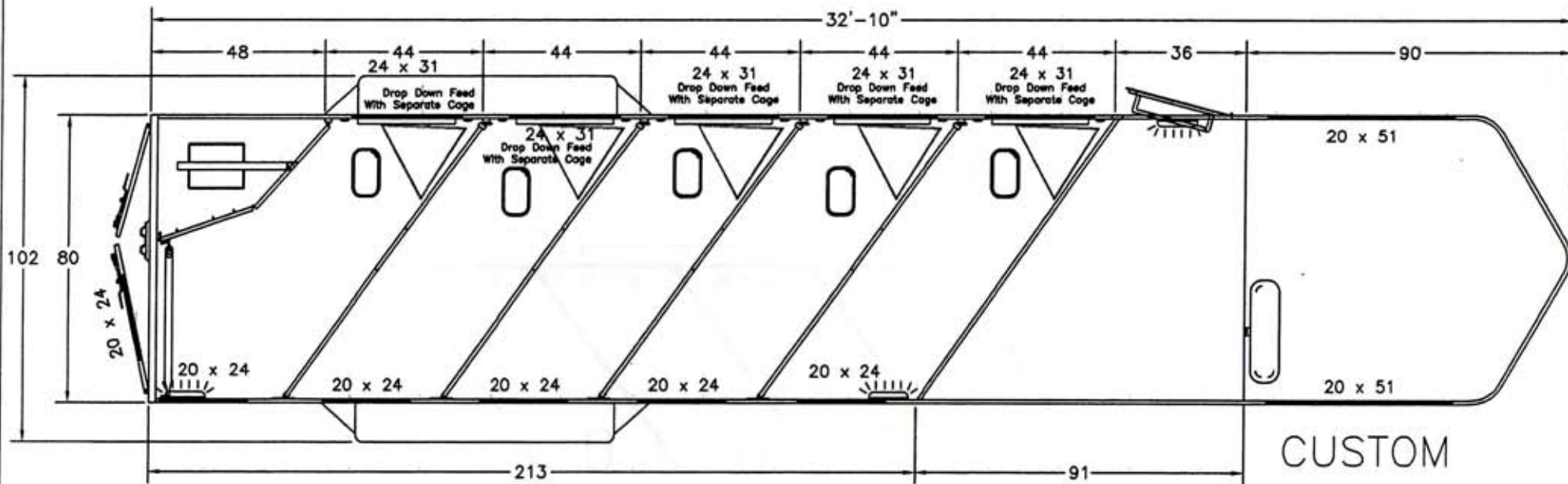

5 Horse Gooseneck Slant With Dress

Drawn: TLS	Date: 12/26/1997	Scale: 1:42	Tolerance: $\pm \frac{1}{16}$	Rev. 3/26/04
5 Horse Gooseneck Slant w/Dress				
 Hawk Trailers MANAWA, WI				

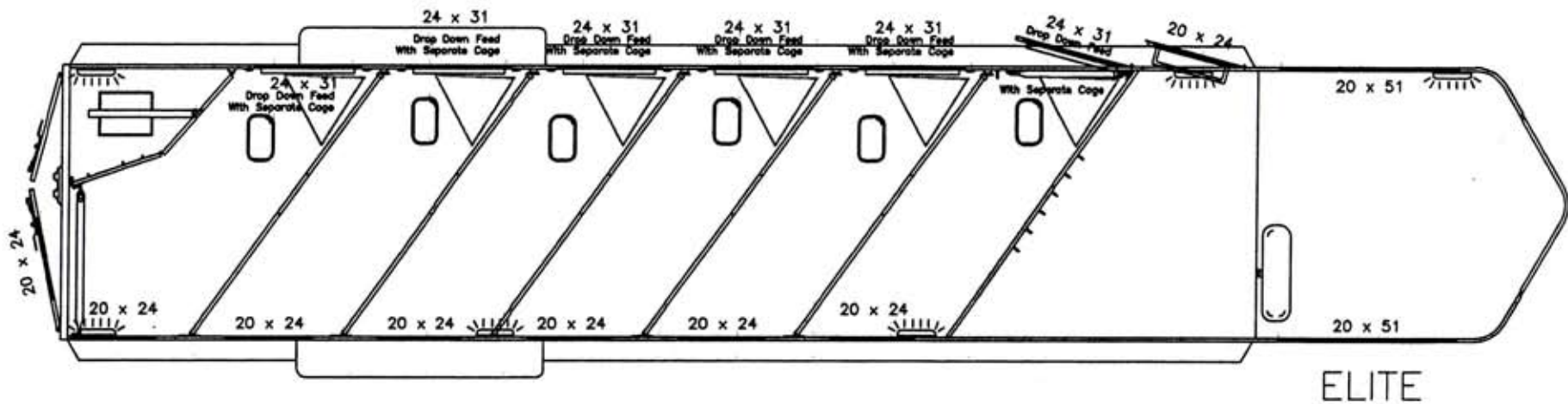
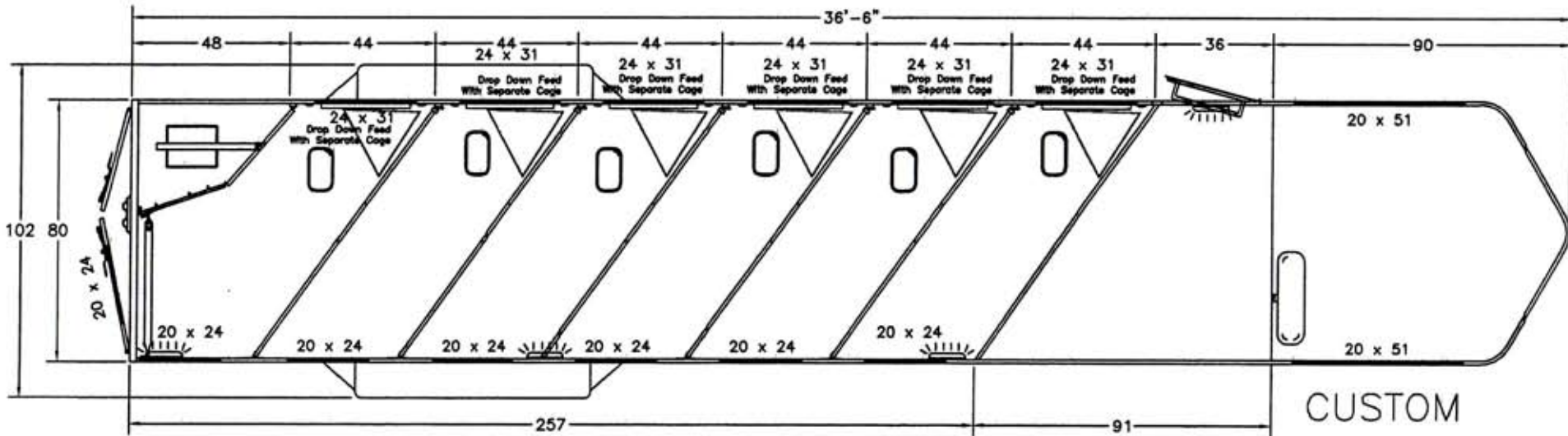

6 Horse Gooseneck Slant With Dress

Drawn: TLS	Date: 12/26/1997	Scale: 1:48	Tolerance: $\pm \frac{1}{16}$	Rev. 3/26/04
6 Horse Gooseneck Slant w/Dress				
 Hawk Trailers MANAWA, WI				